

# SPECIFICATION

# 产品规格书

REFOND P/N 产品型号

RF-W1SA35IS-A47A

R&D 研发

Mass Product 量产供货



## Contents 目录

1. Description 产品介绍	4
1.1 General Description 产品描述	4
1.2 Features 产品特征	4
1.3 Application 产品应用	4
1.4 Package Dimension 封装尺寸	5
1.5 Product Parameters 产品参数	6
1.6 Typical optical characteristics curves 典型光学特性曲线	7
2. Packaging 产品包装	11
2.1 Packaging Specification 包装规格	11
2.1.1 Carrier Tape Dimension 载带尺寸	11
2.1.2 Reel Dimension 卷盘尺寸	11
2.1.3 Label Form Specification 标签规格	12
2.2 Moisture Resistant Packing 防潮包装	12
2.3 Cardboard Box 包装纸箱	13
2.4 Reliability Test Items And Conditions 信赖性测试项目及条件	13
2.5 Criteria For Judging Damage 失效判定标准	14
3. SMT Reflow Soldering Instructions SMT 回流焊说明	15
3.1 SMT Reflow Soldering Instructions SMT 回流焊说明	15
3.1.1 Soldering Iron 烙铁焊接	17
3.1.2 Repairing 修补	17
3.1.3 Cleaning 清洗	17
4. Handling Precautions 产品使用注意事项	18
4.1 Handling Precautions 产品使用注意事项	18
4.1.1 Storage 贮存	18
4.1.2 Static Electricity 静电	19
4.1.3 Reverse voltage protection 反压保护	19
4.1.4 The safe temperature for LEDs working 温度保护	19



4.1.5 Directionsfor Use 使用指南.....	20
4.1.6 Others 其它事项 .....	22
4.1.7 Declare 申明.....	23



## 1. Description 产品介绍

### 1.1 General Description 产品描述

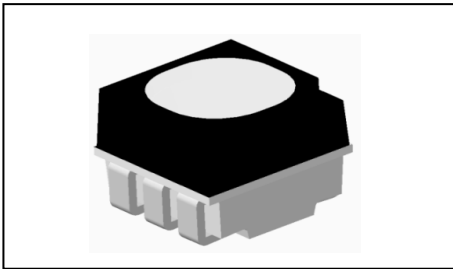

The product is a full-color LED device, High contrast(Surface brush design ). The product size: 3.7mmX3.5mmX2.8mm.

该产品为全彩 LED 器件，高对比度(表面刷墨设计)，产品尺寸: 3.7mmX3.5mmX2.8mm。

### 1.2 Features 产品特征

- ▶ Extremely wide viewing angle. 发光角度大
- ▶ High luminous Intensity, Low power dissipation, Good reliability and Long life.  
光强度高、功耗低、可靠性好、寿命长
- ▶ Water-resistant (IPX6). 防水等级(IPX6)
- ▶ Moisture sensitivity level: 5a. 潮湿敏感等级:5a
- ▶ RoHS compliant. 满足RoHS要求
- ▶ Matte surface. 哑光表面
- ▶ Pb-free reflow soldering application. 无铅回流焊

### 1.3 Application 产品应用

- ▶ Outdoor full-color video screen. 户外全彩显示屏
- ▶ Indoor and outdoor decorative lighting. 室内外装饰照明
- ▶ Amusement. 娱乐产品
- ▶ General use. 其他应用



## 1.4 Package Dimension 封装尺寸

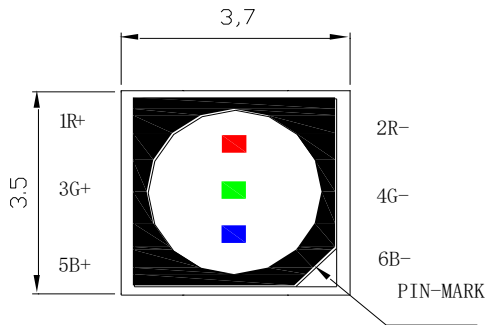

Fig.1-1 Top view 正面视图

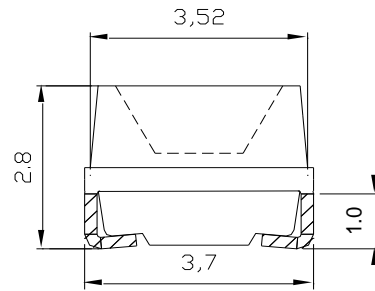

Fig.1-2 Side view 侧面视图

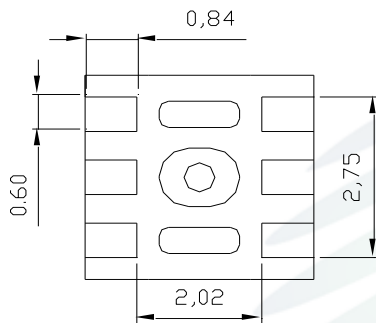

Fig.1-3 Bottom view 背面视图

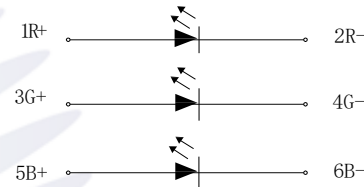

Fig.1-4 Polarity 极性

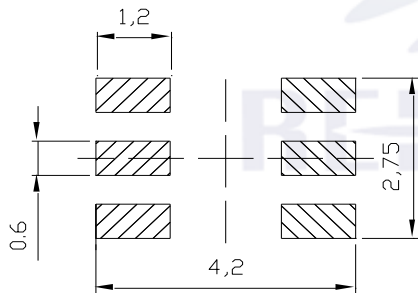

Fig.1-5 Soldering patterns 推荐焊盘

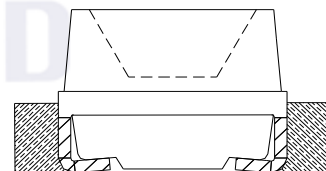
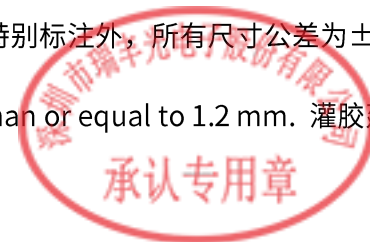

Fig.1-6 Glue filling 灌胶

### Notes 备注:

1. All dimensions units are millimeters. 所有尺寸标注单位为毫米
2. All dimensions tolerances are  $\pm 0.1$  mm unless otherwise noted. 除特别标注外, 所有尺寸公差为  $\pm 0.1$  毫米
3. Recommendation for glue filling: filling height must be higher than or equal to 1.2 mm. 灌胶建议: 灌胶高度必须大于等于 1.2 mm



## 1.5 Product Parameters 产品参数

Table 1-1 Electrical / Optical Characteristics at Ts=25°C 电性与光学特性

Item 项目	Symbol 符号	Test Condition 测试条件	Value			Unit 单位
			R	G	B	
Reverse Current (反向电流)	I <sub>R</sub>	V <sub>R</sub> =5V	6	6	6	μA
Forward Voltage (正向电压)	V <sub>F (min)</sub>	R I <sub>F</sub> = 20mA G I <sub>F</sub> = 20mA B I <sub>F</sub> = 20mA	1.7	2.5	2.5	V
	V <sub>F (max)</sub>		2.4	3.3	3.3	V
Dominant Wavelength 主波长	λ <sub>D</sub>		617~ 628	520~545	460~475	nm
			5nm per Bin	3nm per Bin	3nm per Bin	
Spectrum Radiation Bandwidth 半波宽	Δλ		24	38	30	nm
Luminous Intensity 发光强度	I <sub>V(min)</sub>		640	1200	300	mcd
	I <sub>V(avg)</sub>		900	1700	450	mcd
	I <sub>V(max)</sub>		1325	2550	675	mcd
	BIN Range		1:1.3	1:1.3	1:1.3	
Viewing Angle (发光角度)	2θ <sub>1/2</sub>		110			deg

Table 1-2 Absolute Maximum Ratings at Ts=25°C 最大额定参数

Parameter (参数)	Symbol (符号)	Absolute Maximum Ratings (最大额定参数)			Unit 单位
		R	G	B	
Forward Current (正向电流)	I <sub>F</sub>	25	20	20	mA
Reverse Voltage (反向电压)	V <sub>R</sub>	5	5	5	V
Operating Temperature (工作温度)	T <sub>OPR</sub>	-30 ~ +85			°C
Storage Temperature (储存温度)	T <sub>STQ</sub>	-40 ~ +100			°C
Power Dissipation (功率)	P <sub>D</sub>	60	68	68	mW
Total Junction Temperature (结温)	T <sub>J</sub>	105	105	105	°C
Electrostatic Discharge (HBM) (静电)	E <sub>SD</sub>	1000V			

Notes 备注:

1. The above forward voltage measurement allowance tolerance is  $\pm 0.1V$ . 上述电压的测试公差范围  $\pm 0.1V$ 。
2. The above Tolerance of measurement of dominant wavelength  $\pm 1nm$ . 上述波长的测试公差范围  $\pm 1nm$ 。
3. The above luminous intensity measurement allowance tolerance  $\pm 10\%$ . 上述发光强度的测试公差范围  $\pm 10\%$ 。
4. Care is to be taken that power dissipation does not exceed the absolute maximum rating of the product. 使用功率不能超过规定的最大额定值。
5. All measurements were made under the standardized environment of Refond. 所有测试都是基于瑞丰现有的标准测试平台。
6. Luminous intensity range is for reference only,specific parameters please refer to the label. 发光强度范围仅供参考,请以实物标签为准。

### 1.6 Typical optical characteristics curves 典型光学特性曲线

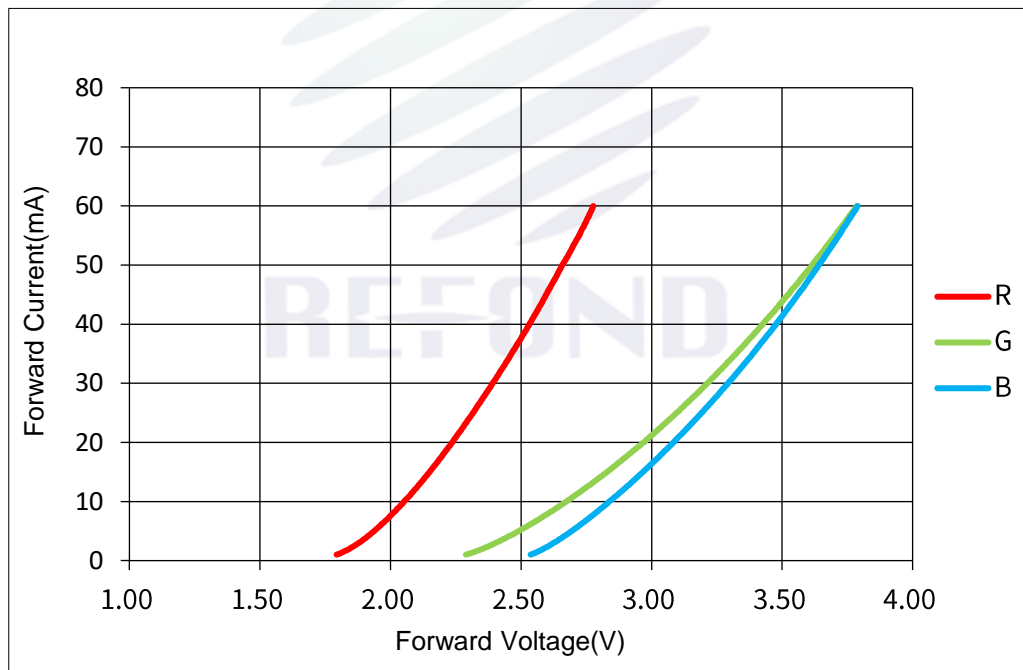

Fig 1-6 Forward Voltage Vs. Forward Current 伏安特性曲线



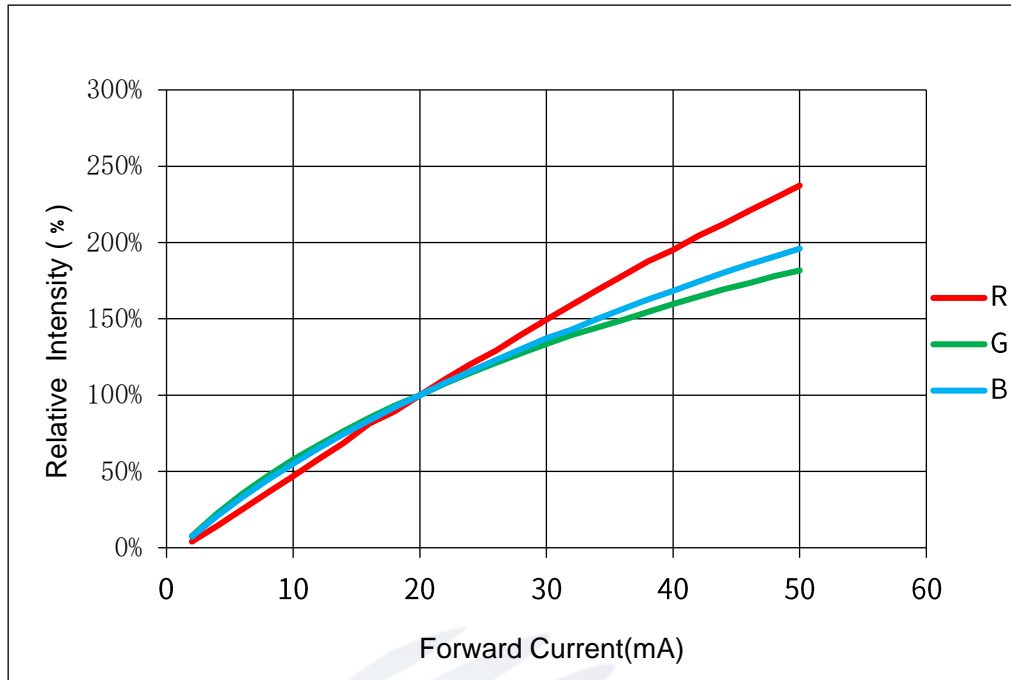

Fig 1-7 Forward Current Vs. Relative Intensity 正向电流与相对光强特性曲线

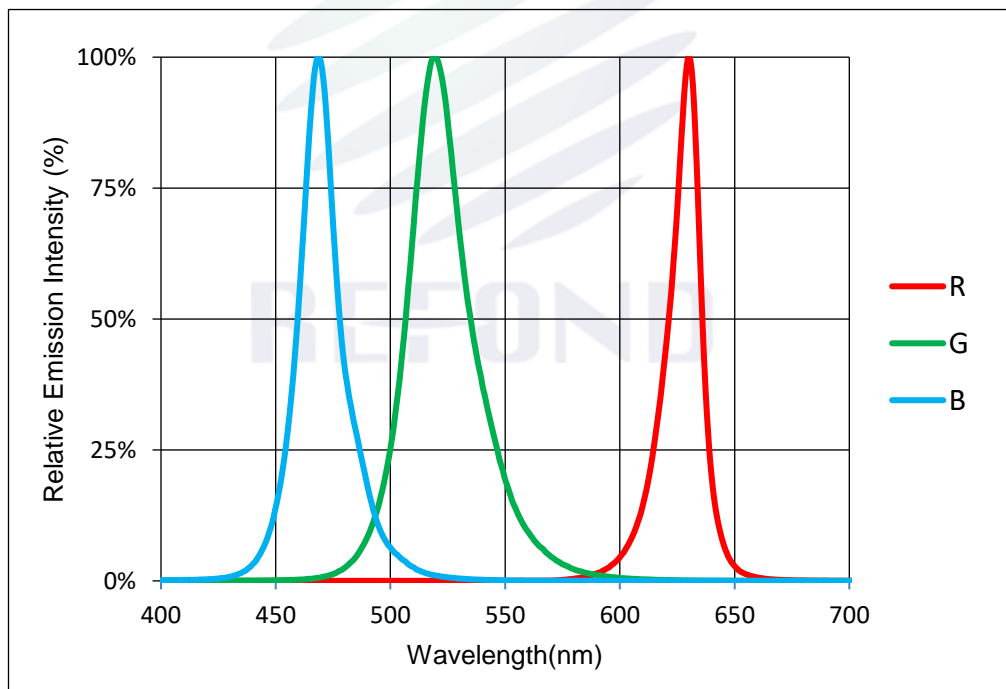

Fig 1-8 Luminous Intensity VS Ambient Temperature 相对光强与环境温度曲线





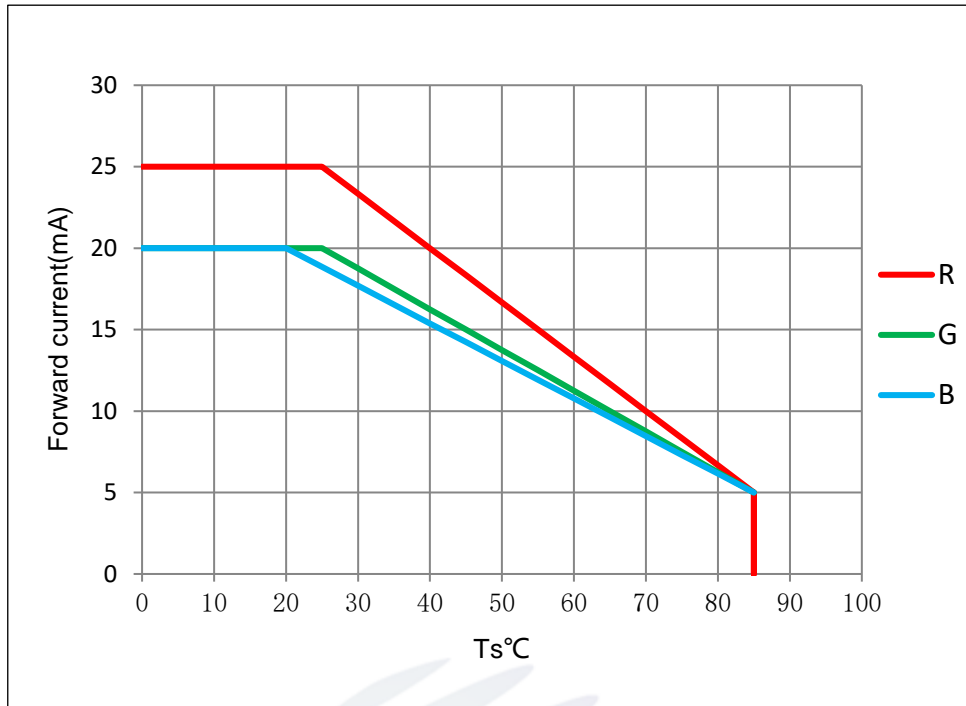

Fig 1-9 Solder Temperature Vs Forward Current 管脚温度与正向电流特性曲

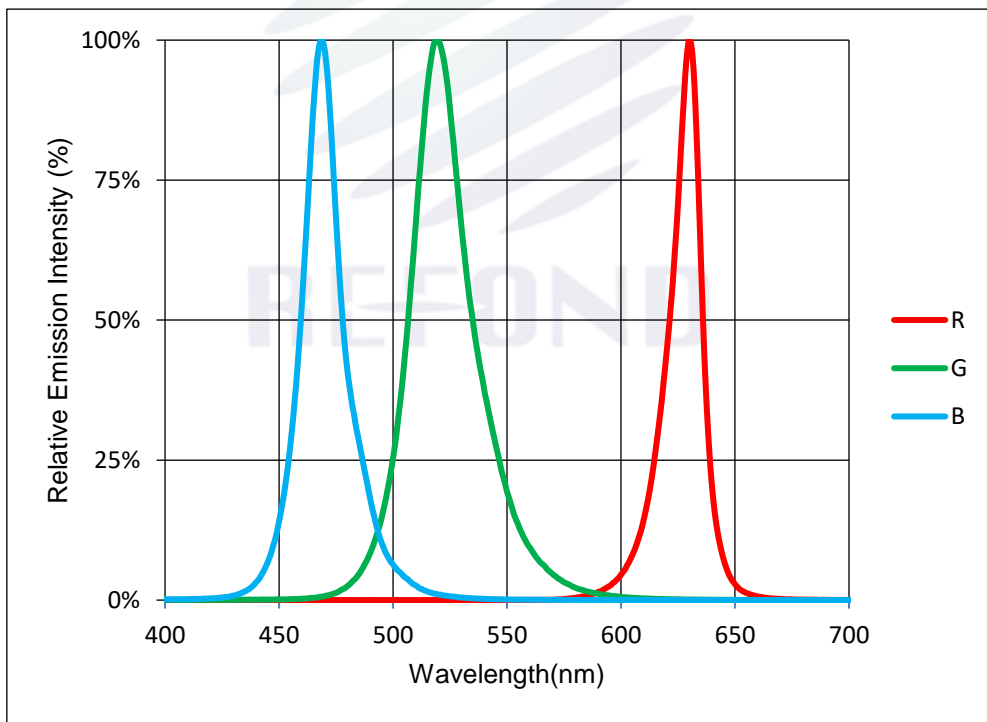

Fig 1-10 Spectrum Distribution 光谱分布特性曲线



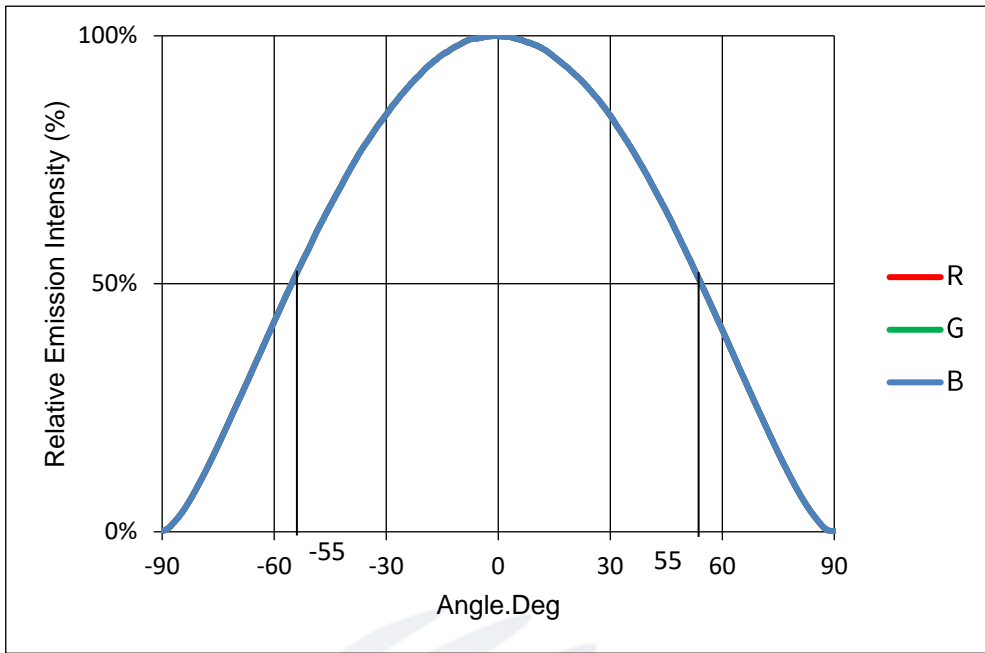

Fig 1-11 Directivity X-X radiation angle X轴方向辐射角度

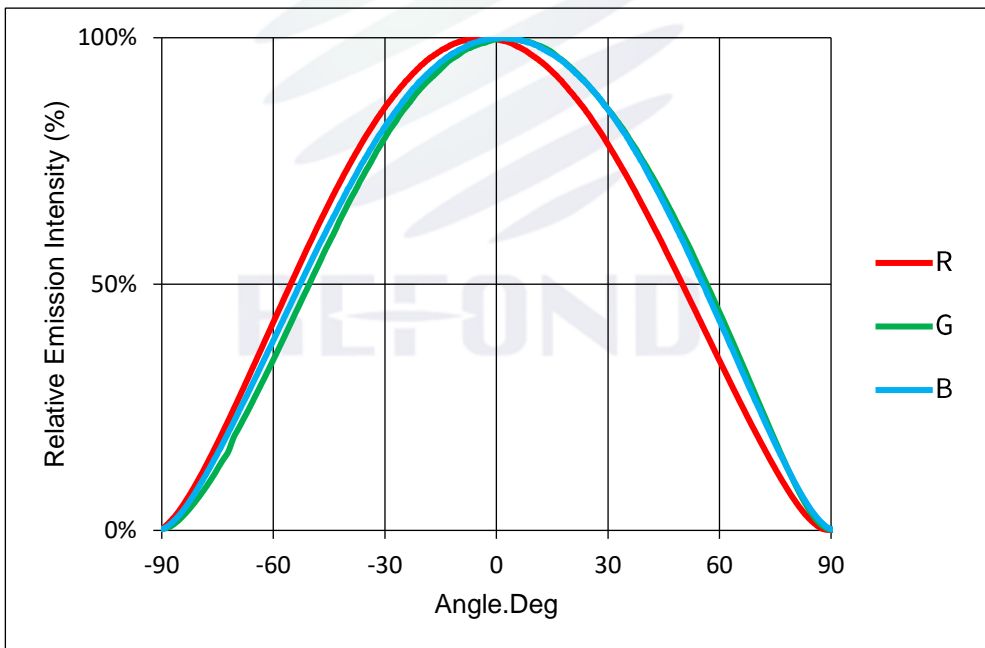

Fig 1-12 Directivity Y-Y radiation angle Y轴方向辐射角度



## 2. Packaging 产品包装

### 2.1 Packaging Specification 包装规格

Package:4000pcs/reel.包装每卷 4000pcs.

#### 2.1.1 Carrier Tape Dimension 载带尺寸

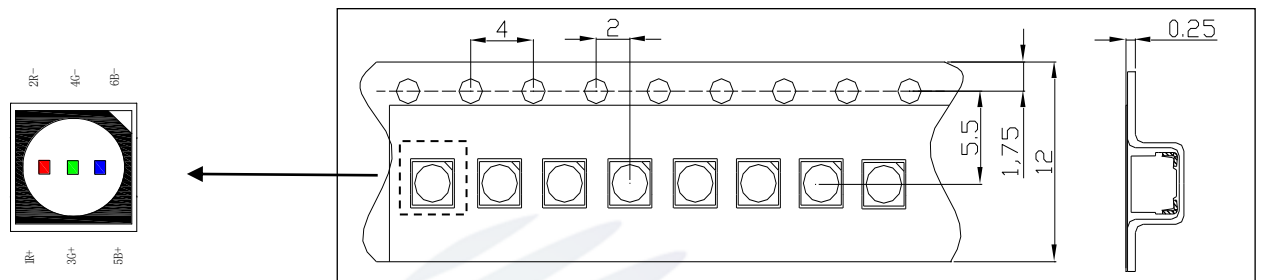

Fig.2-1 Carrier Tape Dimension 载带尺寸

#### 2.1.2 Reel Dimension 卷盘尺寸

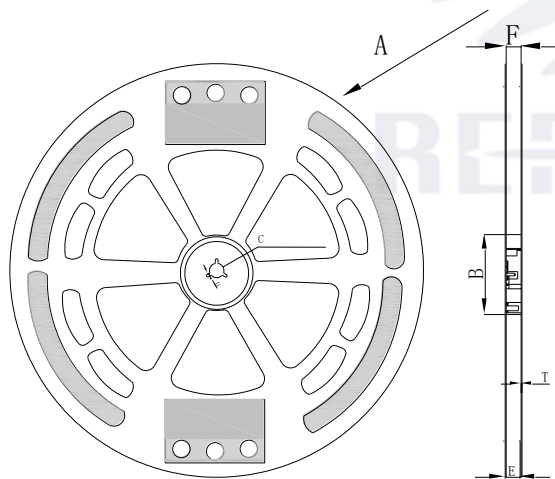

Fig.2-2 Reel 卷盘

Table 2-1 Dimension 描述

A	400±2mm
B	100.0±0.4mm
C	14.3±0.3mm
D	2.6±0.2mm
E	16.4±0.3mm
F	12.7 + 0.8/-0.3 mm
T	1.9±0.2mm

#### Notes 备注:

The tolerances unless mentioned ±0.1mm. Unit : mm 注：未注公差为±0.1毫米；尺寸单位：毫米。

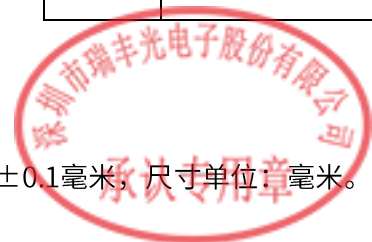

### 2.1.3 Label Form Specification 标签规格

Table 2-2 Description 描述

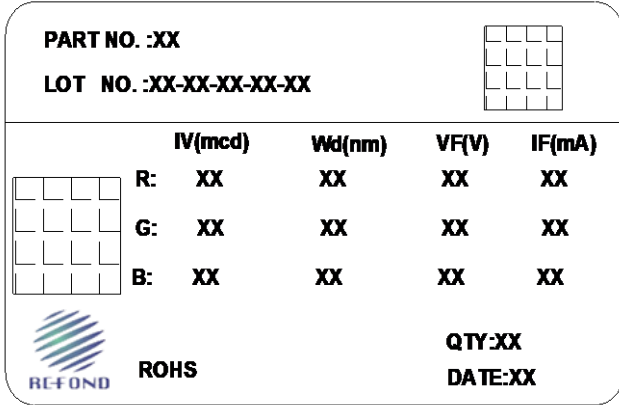

PART NO.	Part Number 品名
LOT NO.	Lot Number + Packing Machine No. + Serial Number +BIN No. + Quantity (K) 批次号 +包装机台号+流水号+BIN号+数量 (K)
IV	Llight intensity 光强
VF	Forward Voltage 正向电压
Wd	Wavelength 波长代码
IF	Forward current 正向电流
QTY	Packing Quantity 数量
DATE	Made Date 生产日期

Fig 2-3 Label 标签

### 2.2 Moisture Resistant Packing 防潮包装

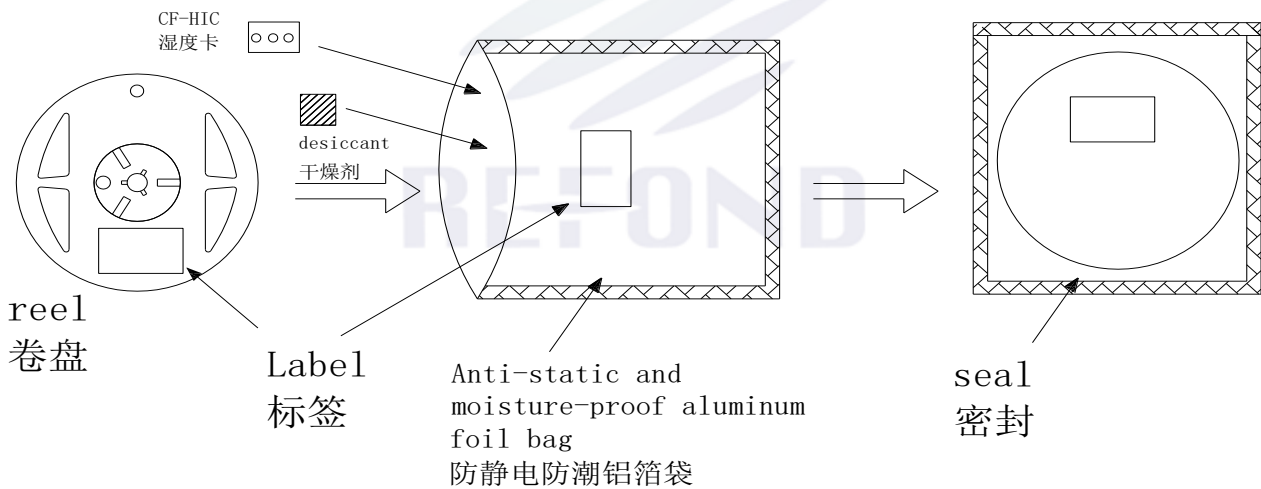

Fig.2-4 Pack 包装



## 2.3 Cardboard Box 包装纸箱

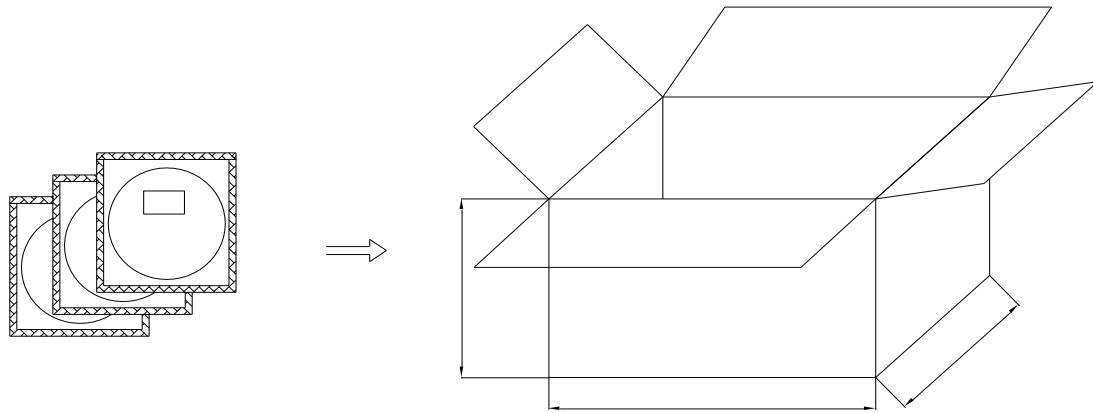

Fig.2-5 Box 包装箱

## 2.4 Reliability Test Items And Conditions 信赖性测试项目及条件

Table 2-3 Reliability Condition 可靠性条件

Test Items 项目	Ref.Standard 参考标准	Test Condition 测试条件	Time 时间	Quantity 数量	Ac/Re 接收/拒收
Resistance to Soldering Heat 耐焊接热	JESD22-B106	Temp:260°Cmax T=10 sec	3times	22pcs.	0/1
Thermal Shock 冷热冲击	JEITAED-4701 300 307	-40°C 15min ↑↓10s 100°C 15min	500cycle	22pcs.	0/1
Moisture Resistance 防潮性	IPC/JEDEC J-STD-020D.1	1. Moisture Absorption Ta=85°C/ RH=85%/12HR 2. Tsol=260°C, T=10s Reflow Soldering	3times	22pcs.	0/1
High Temperature Storage 高温保存	JEITAED-4701 200 201	Temp:100°C	1000hrs.	22pcs.	0/1



Low Temperature Storage 低温保存	JEITA ED-4701 200 202	Temp:-40°C	1000hrs.	22pcs.	0/1
Room Temperature Operating Life 常温寿命测试	JESD22-A108	T <sub>A</sub> =25°C I <sub>F</sub> =20mA	1000hrs.	22pcs.	0/1
High Temperature High Humidity Life Test 高温高湿寿命测试	JESD22-A101	85°C/ 85%RH I <sub>F</sub> =10mA	500hrs.	22pcs.	0/1
Temperature Humidity Storage 高温高湿储存	JEITA ED-4701 100 103	T <sub>A</sub> =85°C RH=85%	1000hrs.	22pcs.	0/1
Low Temperature Life Test 低温寿命	JESD22-A108D	T <sub>A</sub> =-40°C, I <sub>F</sub> =20mA	1000hrs.	22pcs.	0/1

## 2.5 Criteria For Judging Damage 失效判定标准

Table 2-4 Criteria 标准

Test Items 项目	Symbol 符号	Test Condition 测试条件	Criteria For Judgement 判定标准
Forward Voltage 正向电压	V <sub>F</sub>	I <sub>F</sub> =20mA	Initial Data ±10% 初始值 ±10%
Reverse Current 反向电流	I <sub>R</sub>	V <sub>R</sub> = 5V	I <sub>R</sub> ≤ 10μA
Luminous Intensity 光强	I <sub>v</sub>	I <sub>F</sub> =20mA	Average I <sub>v</sub> degradation rate ≤ 30% 平均 I <sub>v</sub> 衰减 ≤ 30%
Material appearance 外观	/	/	No internal cracks, no material between stripped, no dead light 材料无内部裂痕、无剥离、无死灯

Notes 备注:

1. The Reliability tests are based on Refond existing test platform. 可靠性测试基于瑞丰现有的测试标准。
2. The above reliability tests is based on the verification of a single/strip LED of Refond's existing experimental platform, the reliability experiment was taken under good heat dissipation conditions. when customers applies the LED to the series and parallel circuit, should take consideration of all the factors such as the current, voltage distribution, heat dissipation and others. 以上可靠性测试是基于瑞丰现有实验平台单颗/条 LED 在良好散热条件验证下的结果。客户端将 LED 应用于串、并联线路时, 需自行评估电流、电压分配、散热等问题。

### 3. SMT Reflow Soldering Instructions SMT 回流焊说明

#### 3.1 SMT Reflow Soldering Instructions SMT 回流焊说明

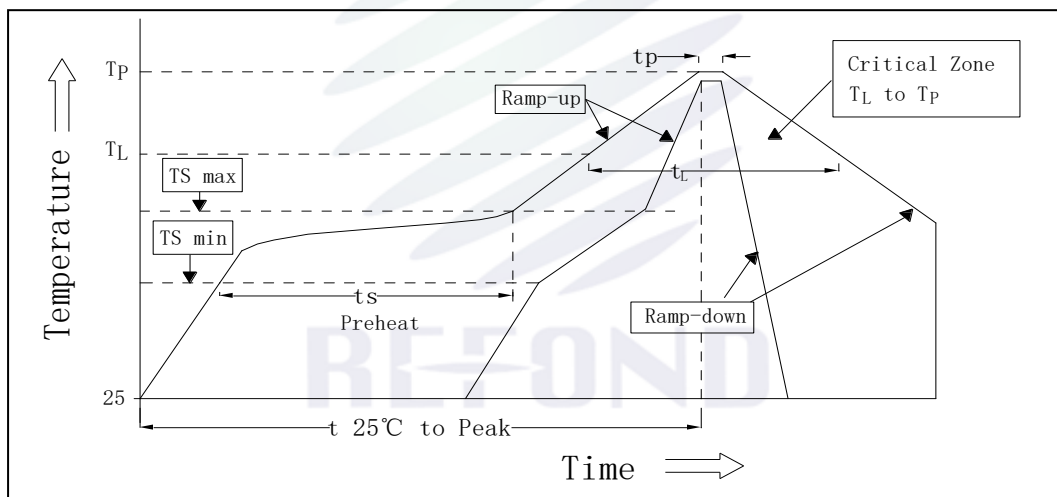

Fig.3-1 Profile 曲线



Table 3-1 Description 描述

Average temperature rise speed平均升温速度 (T <sub>max</sub> 至T <sub>P</sub> )	Max 4 °C/ s 最高4 °C/秒
Preheating: minimum temperature预热: 最低温度 (T <sub>min</sub> )	150 °C
Preheating: Max temperature预热: 最高温度 (T <sub>max</sub> )	200 °C
Preheating: Time预热: 时间 (T <sub>min</sub> 至T <sub>max</sub> )	60s-120s 60 - 120秒
Time limited to maintain high temperature: the temperature 限时维持高温: 温度 (T <sub>L</sub> )	217 °C
Time limited to maintain high temperature: The Time 限时维持高温: 时间 (t <sub>L</sub> )	Max 60s 最多60秒
Peak /Classification of temperature: 峰值 / 分类温度 (T <sub>P</sub> )	245 °C
Time limit classification of peak temperature time 限时峰值分类温度: 时间 (t <sub>p</sub> )	Max 10s 最多10秒
Hold time within 5 °C with the actual peak temperature (T <sub>P</sub> ) 与实际峰值温度 (T <sub>P</sub> ) 相差 5 °C 以内的保持时间	Max 30s 最多30秒
Cooling speed 降温速度	Max 6 °C/ s 最高6 °C/秒
Needed time from 25 °C to T <sub>p</sub> 25 °C 升至峰值温度所需时间	Max 8 minutes 最多8分钟

Notes 备注:

- 1.Reflow soldering should not be done more than one times.回流焊接最多只能进行一次。
- 2.It is recommended that use the middle temperature solder paste.推荐使用中温锡膏生产加工。
- 3.Stress on the LEDS should be avoided during heating in soldering process.在回流焊接过程中,不要对 LED 施加任何压力。
- 4.After soldering ,do not deal with the product before its temperature drop down to room temperature.在焊接完成后,待产品温度下降到室温后,再进行其它处理。
5. Nitrogen reflow soldering is recommended. Air flow soldering conditions can cause optical degradation, caused by heat or atmosphere. 建议使用氮气回流焊, 在空气中焊接条件可能会因热或气体氛围而导致光学性能





下降.

6. This product can differ in optical characteristics depending on the number of reflow cycles. In a single display, only LEDs with same number of reflow cycles should be used regardless of the application type, such as rental and/or permanent installations. 本产品的光学特性可能会因回流循环次数而异。在单个显示屏中，无论使用哪种类型（例如租赁或永久安装），都应仅使用回流次数相同的LED。

7. This LED is designed to be reflow soldered on to a PCB. If dip soldered, cannot guarantee its reliability. 此LED设计为回流焊接到PCB上，如果采用浸焊，无法保证其可靠性。

### 3.1.1 Soldering Iron 烙铁焊接

(1) When hand soldering, keep the temperature of iron below less 300°C less than 3 seconds  
当手工焊接时，烙铁的温度必须小于300°C，时间不可超过3秒。

(2) The hand solder should be done only one time. 手工焊接只可焊接一次。

### 3.1.2 Repairing 修补

Repair should not be done after the LEDs have been soldered. When repairing is unavoidable, a double-head soldering iron should be used (as below figure). It should be confirmed in advance whether the characteristics of LEDs will or will not be damaged by repairing.

LED回流焊后不应该修复，当必须修复时，必须使用双头烙铁，而且事先应确认此种方式会不会损坏LED本身的特性。

### 3.1.3 Cleaning 清洗

The LEDs should not be cleaned with water, benzene, and/or thinner. Alcohol is recommended for cleaning. Before cleaning with other similar solvents, please make sure that the solvent used will not cause damage to the LED. Do not use ionic liquids containing "Cl" and "S" elements to clean the LED surface.

不应用水、苯和/或稀释剂清洗led。推荐使用酒精进行清洗，使用其它类似溶剂清洗前，请先确认使用的溶剂不会对LED造成损伤。不要使用含有“Cl”“S”元素的离子液体清洗LED表面。



## 4.Handling Precautions 产品使用注意事项

### 4.1Handling Precautions 产品使用注意事项

#### 4.1.1 Storage 贮存

(1) Moisture proof and anti-electrostatic package with moisture absorbent material is used, Suggest storage time is less than 6 months.

本产品使用密封防潮抗静电袋包装,并附有干燥剂, 储存时间不要超过6个月.

(2) Storage condition: temperature  $\leq 30^{\circ}\text{C}$ , humidity  $\leq 60\% \text{ RH}$ .

开封前, 产品必须储存在温度 $\leq 30^{\circ}\text{C}$ 、相对湿度 $\leq 60\% \text{ RH}$ 的环境里.

(3) Before opening the package, please check the package for air leaks, if there exists any air leaks, please return the product to our company for package after dehumidification by baking before your second use.

在开包装之前, 请先检查包装袋有无漏气, 如果有漏气现象, 请退回我司重新烘烤除湿包装后再使用。

(4) After the package is opened, the product must be used in the specified environment of temperature below  $30^{\circ}\text{C}$ /humidity below  $60\% \text{ RH}$ , and soldered within 12HR. Unused material must be stored in the environment of temperature below  $30^{\circ}\text{C}$ /humidity below  $10\% \text{ RH}$ , These surplus products should be baked  $65 \pm 5^{\circ}\text{C}/24\text{H}$  before next use.

包装袋开启后,产品必须: 在规定环境温度 $30^{\circ}\text{C}$ 以内、湿度 $60\% \text{ RH}$ 以下的条件中使用; 并且需要在12小时内焊接完毕; 未使用完的材料需存储于温度: $30^{\circ}\text{C}$ 以内, 湿度: $10\% \text{ RH}$ 以内的环境中, 下次使用前需烘烤使用, 烘烤条件: $65 \pm 5^{\circ}\text{C}/24\text{H}$ 。

(5) Before SMT, LEDs need to be baked, baking requirement as below: 上线贴片前, 必须对产品进行烘烤除湿, 烘烤条件如下:

Customer pre-treatment conditions before use 客户使用前处理方式				
Condition before use 使用前情况:	undamped, Production date: 2 months 未受潮, 生产日期2个月 以内	undamped, Production date: 2-6 months 未受潮, 生产日期为 2-6个月	undamped, Production date : 6-12 months 未受潮, 生产日期为 6-12个月	damped, or Production date : exceed 12 months 已受潮, 或生产日期超过12个月
Pre-treatment 处理方式:	Baked $65^{\circ}\text{C} \pm 5^{\circ}\text{C}/12\text{H}$ 烘烤 $65^{\circ}\text{C} \pm 5^{\circ}\text{C}/12\text{H}$	Baked $65^{\circ}\text{C} \pm 5^{\circ}\text{C}/24\text{H}$ 烘烤 $65^{\circ}\text{C} \pm 5^{\circ}\text{C}/24\text{H}$	Baked $65^{\circ}\text{C} \pm 5^{\circ}\text{C}/48\text{H}$ 烘烤 $65^{\circ}\text{C} \pm 5^{\circ}\text{C}/48\text{H}$	Return to the original factory for processing 退回原厂处理

#### 4.1.2 Static Electricity 静电

Static electricity and surge voltage damage the LEDs. Damaged LEDs will show some unusual characteristics such as the forward voltage becomes lower, or the LEDs do not light at the low current and even not light. All devices, equipment and machinery must be properly grounded. At the same time, it is also recommended that anti-electrostatic wrist bands, pads, uniforms, gloves or containers can be used as effective measures when dealing with the LEDs.

静电和电涌会导致产品特性发生改变,例如正向电压降低等,如果情况严重甚至会损毁产品。所以在使用时必须采取有效的防静电措施。所有相关的设备和机器都应该正确接地,同时必须采取其他防止静电和电涌的措施。使用防静电手环,防静电垫子,防静电工作服、工作鞋、手套,防静电容器,都是有效的防止静电和电涌的措施。

#### 4.1.3 Reverse voltage protection 反压保护

In generally the reverse current of LED is very small, it can't effect using the component normally, but when it often suffered the reverse voltage which exceed the limits of the component than it will be damaged, the reverse current increases rapidly causing the string light display gray scale so when designing, please pay attention to control the reverse voltage we suggest the reverse voltage less than 5V.

通常 LED 的反向漏电流都会很小,不会影响正常使用。如果长期遭受超过其所能承受的反向电压冲击时,LED 会损伤,反向漏电流会迅速变大,引起显示屏零灰度下串光的发生。在设计中,要注意控制反向电压,建议加在 LED 上的反向电压值不超过 5V。

#### 4.1.4 The safe temperature for LEDs working 温度保护

(1) The high temperature will make the LED's Luminous Intensity deceased radically, if LEDs worked in hot environment for a long time, they will be disabled easily. When LEDs are working in a closed array, we suggest that the LED's surface temperature should be lower than 55°C and the leg's temperature should be lower than 75°C.

LED 在高温条件下,衰减会加速,本身应力也会增大,若长期处于高温环境下,极容易出现失效。对于高密度排列使用的情况,建议在使用过程中灯面温度不超过 55°C,灯脚温度不超过 75°C。

(2) Proper thermal management is an important when designing products with LEDs. LED die temperature is affected by PCB thermal resistance and LED spacing on the board. Please design

products in a way that the LED die temperature does not exceed the maximum junction temperature (TJ).

在设计 led 产品时, 适当的热管理是很重要的。LED 芯片温度受 PCB 热阻和 LED 在板上的间距影响。请将产品设计成 LED 芯片温度不超过最高结温 (TJ) 的方式。

(3) Drive current should be determined for the surrounding ambient temperature (TA) to dissipate the heat from the product.

驱动电流应根据周围环境温度 (TA) 来确定, 以散发产品产生的热量。

#### 4.1.5 Directions for Use 使用指南

(1) During designing a circuit, the current goes through each LED chip must not exceed the Absolute Max Rating current specified for each chip.

在打开包装之前, 必须检查包装袋是否完好。在设计电路时, 流经每个 LED 芯片的电流不得超过为每个芯片指定的绝对最大额定电流。

(2) It is recommended that each LED chip is driven by a constant current.

建议每个 LED 芯片均由恒定电流驱动。

(3) When having the two or more dices within this product at the same time, the total power dissipation for the LED package must be within the max value specified in this specification.

当需要同时应用两个或以上的灯珠时, LED 封装的总功耗必须在此规格书指定的最大值以内。

(4) This product should be operated with forward current. Make sure the product is not subjected to either forward or reverse voltage while it isn't in use. Especially, DO NOT subject it to continuous reverse voltage because it may cause damage to the LED chip. If the display will not be used for a long time, the main power should be switched off, Dehumidification is necessary before using the screen again.

本产品应在正向电流下使用。确保产品在不使用时不承受正向或反向电压, 尤其不要对它施加连续的反向电压, 因为它可能会损坏 LED 芯片。如果长时间不使用显示屏, 则应关闭主电源, 再次使用前应先进行除湿处理。

(5) Make sure that the reverse voltage will not exceed the Absolute Max Rating when using the LEDs with matrix drive. Ensure that excessive voltages such as lightning surges are not applied to the LEDs.

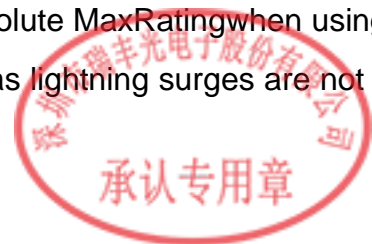

在矩阵驱动的 LED 上使用时，请确保反向电压不超过绝对最大额定值。确保不要将过大的电压（例如雷电）施加到 LED 上。

(6) Aging is recommended in order to detect manufacturing and assembly defects. Particularly, make sure that excessive current and/or voltage is not applied to the LEDs. This aging should be conducted in environments where water condensation does not occur.

建议进行老化以检测制造和组装缺陷；特别要确保没有对 LED 施加过大的电流或电压。该老化应在不发生水凝结的环境中进行。

(7) when the LEDs are used in the following environments, incorporate sufficient measures into the display to prevent debris, water/moisture and gases that will adversely affect the product.

- where water vapor is abundant
- where water condensation is likely to occur
- where water is likely to splash onto the LEDs
- where frost is likely to form on the surface of the LEDs (e.g. freezer, ice skating rink, etc.)
- where dust, dirt, debris, loose metallic materials and/or gases that will adversely affect the product are present

在以下环境中使用LED时，请在显示屏中采取足够的措施，以防止会对产品产生不利影响的碎屑、水分和气体。

- 水蒸气丰富的地方
- 可能发生水凝结的地方
- 水很可能溅到LED上的地方
- LED的表面可能会结霜的地方（例如冰箱，溜冰场等）
- 存在对产品有不利影响的灰尘，污垢，碎屑，松散的金属材料或气体

(8) In areas where hydrogen sulfide, which is a sulfide-based gas, is present (e.g. hot springs and volcanic areas), and where salt is abundant (e.g. coastal areas), the life may be shortened.

在存在硫化氢（一种基于硫化物的气体）的地区（例如温泉和火山区）以及盐分丰富的地区（例如沿海地区），寿命可能会缩短。

(9) When power is applied for the first time after display's installation, it should not be powered at 100% wattage for the LEDs may have absorbed moisture. Before normal use of this display, operate the display at approximately 20% wattage for an initial time period.

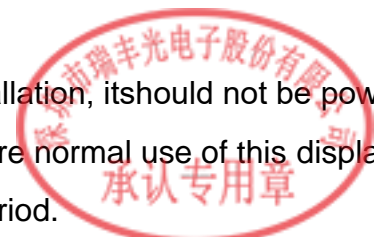



显示屏安装后首次通电时，因为LED可能吸收了水分，不应以100%的功率供电。在正常使用此显示屏前，请在初始时间段内以约20%的功率运行。

(10) If the display units will be rented, those units should be selected carefully to ensure that the display as a whole will appear the same color and brightness.

如果要租借展示，则应仔细选择箱体，以确保整个显示屏的颜色和亮度相同。

(11) If the display modules are loaded onto and/or transported by ship, the moisture environment on the vessel can cause condensation; the display units should be packaged to prevent moisture absorption.

如果显示模块装在船上或由船运输，则船上潮湿的环境可能会导致冷凝；展示柜应包装好以防止吸收水分。

(12) If a display that has been, or is being, used is relocated, it is possible that degradation of the LED has occurred. When transporting this display, provide sufficient protection for the LEDs in addition to the moisture-proof packaging for the display. When this display is reinstalled, ensure to follow the installation instructions for environments and use.

如果重新搬运已经使用或正在使用的显示屏，则可能发生了LED退化。运输此显示屏时，除了要为显示屏提供防潮包装外，还要为LED提供足够的保护。重新安装此显示屏后，请确保遵循有关环境和使用的安装说明。

#### 4.1.6 Others 其它事项

(1) Do not directly touch or handle the epoxy surface. It may damage the internal circuitry. Handle the component along the side surfaces by using forceps or appropriate tools.

请勿直接触摸或操作环氧树脂表面，这可能会损坏内部的电路，拿取时用镊子或合适的工具夹在元件的侧边。

(2) Do not handle the LEDs with bare hands as it will contaminate the LED surface and may affect the optical characteristics: it might cause the LED to be deformed and/or the wire to break, which will cause the LED not to illuminate. The lead could also cause an injury.

请勿裸手操作 LED，因为这会污染 LED 表面并可能影响光学特性：这可能会导致 LED 变形或线材断裂，从而导致 LED 不发光。也可能造成线路受损。

(3) Do not stack assembled PCBs together. Otherwise, it may cause damage to the resin (e.g. cut, scratch, chip, crack, delamination and deformation) and the wire to break causing a catastrophic failure (i.e. the LED not to illuminate).

不要将组装好的 PCB 堆叠在一起。否则，可能会损坏树脂（例如，割伤，刮伤，碎屑，破裂，分层和变形），并且线材会断裂而导致灾难性故障（即 LED 不亮）。

(4) Other precautions, please refer to our "Ruifeng Photoelectric Full color SMD LED device User Manual".

其他注意事项,请参考我司《瑞丰光电全彩 SMD LED 器件使用手册》。

#### 4.1.7 Declare 申明

(1) This specification is written both in English and in Chinese and the latter is formal.

此规格书以中英文方式书写，若有冲突以中文版本为准。

(2) Both the customers and Refond will agree on official specifications of supplied products before a customer's volume production. The specification is valid only after be signed. And Refond reserves the right to further modify the specification for technical reference and sample without noticing the customers.

在量产供货前，瑞丰需与客户签署一份正式的产品规格书并各自备份。规格书签核后方有效，对于作为技术参考以及送样时提供的规格书，瑞丰保留进一步修改而不需通知客户的权力。



### Version History/修订历史

Date日期	Revisor修订者	Version版本	Verifier审核	Remarks备注
2020-06-09	陈宇	E0	张国保	初版发行
2020-07-10	陈宇	E1	张国保	参数变更
2024-06-01	王晓凤	E2	陈宇	支架规格变更及 版本变更
2024-11-25	王晓凤	E3	陈宇	变更包装数量
				





[www.refond.com](http://www.refond.com)



Declare 申明

This specification is written both in English and in Chinese and the latter is formal.

产品规格书以中英文方式书写，若有冲突以中文版本为准。

